



neway

VALVE SEAT CUTTER



INSTRUCTION MANUAL



NEWAY MANUFACTURING, INC.

P.O. Box 188 • Corunna, Michigan 48817 USA

Phone: (989) 743-3458 • **Fax:** (989) 743-5764

Email: info@newaymfg.com

Web: www.newaymfg.com

**BEFORE USING THE TOOLS,
PLEASE READ THIS ENTIRE MANUAL CAREFULLY.**

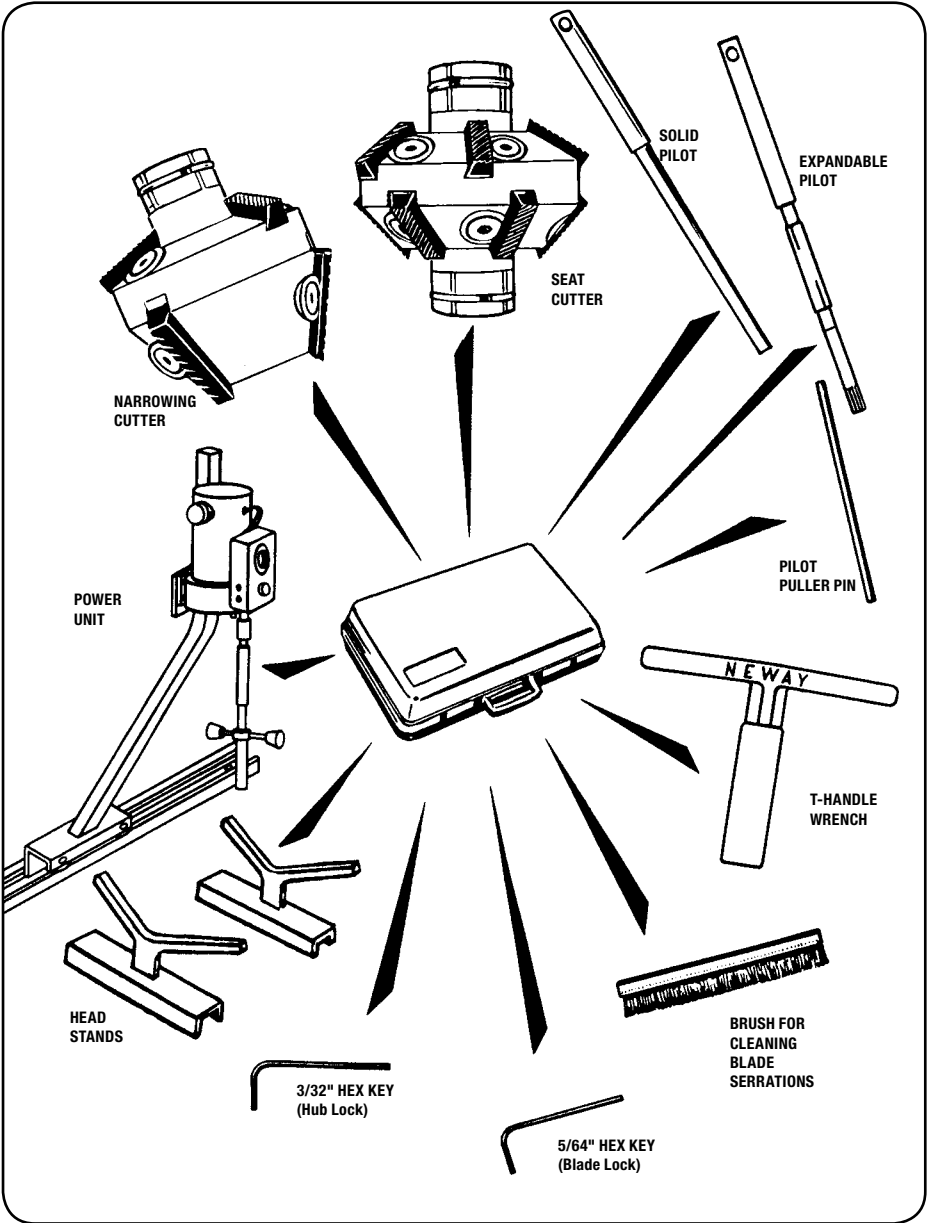

Why Proper Valve Seating is Important	4
Objectives of valve seat reconditioning	
Interference Angle	
Preparation for Cutting Valve Seats	4
Selection and Use of Proper Pilot	5
Solid Pilots	
Expandable Pilots	
Selection and Use of Proper Valve Seat Cutters	6–8
Adjustment of Carbide Blades	
General Instructions	
Detailed Instructions	
Bottom Narrowing Cut	
Top Narrowing Cut	
Final Seat Cut	
Inspecting the Seat	
Changing the Location and/or Width of the Seat	9
Checking Valve Seat Concentricity and Closure	9
Tolerance for Runout (Concentricity)	
Special Application Carbide Blades	10
Radius Blades	
Stepped Blades	
Power Unit	10
Basic Parts List	11–12
Helpful Suggestions	13–14
Troubleshooting	15

Why Proper Valve Seating is Important

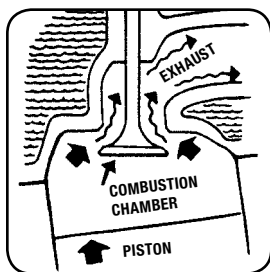

Good valve seats are critical to maintaining compression and horsepower. Poorly seated valves will not only cause compression loss, but will also compromise the ability of the exhaust valve to cool itself by transferring heat through contact with the valve seat. Further, if valve seat concentricity is outside of the allowable limit, mechanical stresses may cause valve failure. A good valve seat:

- Is concentric to the centerline of the valve guide (within OEM specs).
- Is properly located on the valve face.
- Is the proper width.
- Has a surface texture which is conducive to efficient sealing and heat transfer.
- Has the proper angles (contact surface and relief angles above and below contact surface, also referred to as narrowing angles).

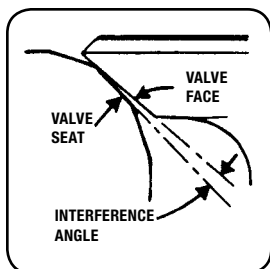
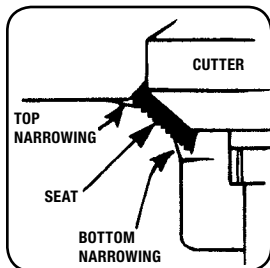

Unless otherwise specified by the OEM, Neway recommends the use of an interference angle (e.g. 45° valve, 46° seat). This will cause maximum pressure between the valve and seat to occur at the outermost diameter.

Preparation for Cutting Valve Seats

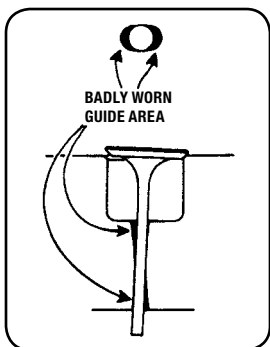

- Clean the cylinder head thoroughly, including the seats and valve guides.
- Check the condition of the valve guides (refer to OEM specs and inspection procedures).
- Badly worn valve guides must be replaced or reconditioned prior to valve seat reconditioning.

Selection and Use of Proper Pilot

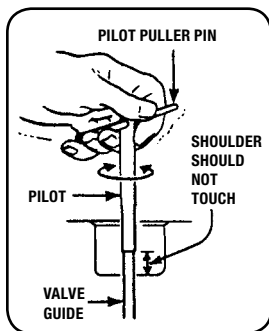

SOLID PILOTS

- Select a pilot the same diameter as the valve guide interior diameter (ID).
- Insert the pilot into the valve guide, twisting slightly, until snug. Pilot shoulder should not touch the valve guide.

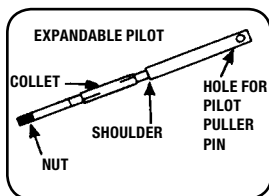

EXPANDABLE PILOTS

- Select a pilot the same diameter as the valve guide ID.
- Insert the pilot into valve guide making sure that the expanding section of the pilot (collet) is completely within the valve guide.

The pilot will not center properly if the collet extends outside of the valve guide even slightly. The collet may also be damaged if expanded while extended outside of the guide.

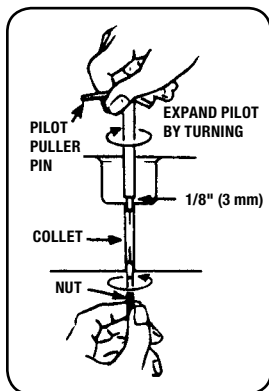

- Pilot shoulder should be about 1/8" (3mm) above the valve guide.
- Using the pilot puller pin, turn the pilot as the nut is held fast at the opposing end. This will expand the collet and secure the pilot into position.
- Collets are .003" smaller than stated diameter and can expand up to .020" (0,5mm).
- The concentricity of the valve seat relies on a tight fitting pilot in a round, straight, guide.

Selection and Use of Proper Valve Seat Cutters

ADJUSTMENT OF CARBIDE BLADES

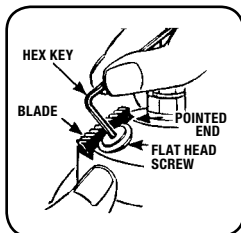
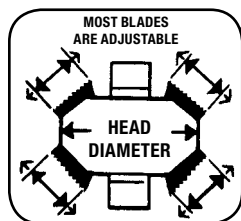

- Before using cutters, check blade adjustment. It is not necessary that all the blades be set to the same position. Simply check that the blades do not cut or gouge the combustion chamber wall and that each blade extends entirely over the surface to be machined. Do not over tighten screws.
- When adjusting blades inward or outward be sure that the blade maintains full contact with the flat of the wedge.
- When changing blades, be sure that the pointed end of the blade points toward the center, or hub, of cutter.

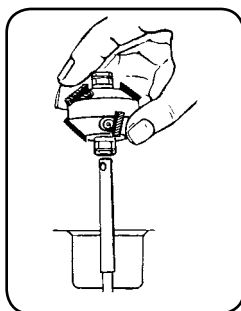

GENERAL INSTRUCTIONS

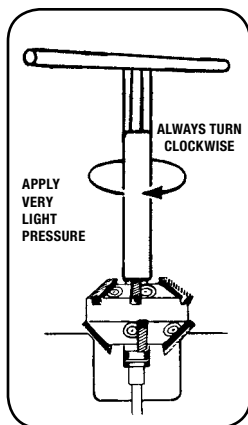

- Select a cutter approximately the same size as the valve head diameter and with the correct angle.
- Place the cutter over the pilot and carefully lower the cutter onto the seat. **DO NOT DROP THE CUTTER.**
- Place T-handle, easy-turn wrench, or hex socket of power unit over the pilot and onto the hex of the cutter.
- Turn clockwise, applying light downward pressure. Use two hands on the T-wrench. Release the downward pressure at the end of each cut. Make one or two turns with no pressure.
- Be sure to maintain downward pressure over the centerline of the pilot. Pay special attention to maintaining centerline pressure in situations where the cutter is cutting on only one side of the seat (e.g. after installation of a new valve guide). Excessive downward pressure may cause the pilot to flex off center. Let the cutter follow the pilot.

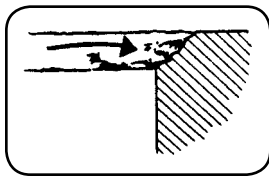

DETAILED CUTTING INSTRUCTIONS

- Inspect the seat. The size of the pits, burns outs, and blow byes will determine the amount of material that must be removed.

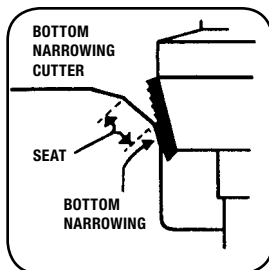

Bottom Narrowing Cut

- Begin the process by cutting the bottom narrowing angle (usually 60° or 75°) using light pressure. Cut until some amount of surface has been cut all the way around, forming a continuous line with the valve seat. This operation raises the bottom edge of the valve seat.

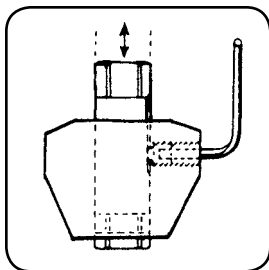

- Note: Some narrowing cutters have moveable hubs and will require adjustment. These hubs are held in position by a set screw. Do not over tighten this set screw.

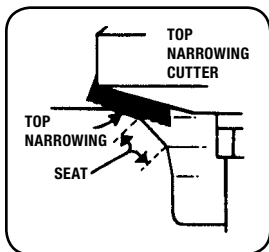

Top Narrowing Cut

- Repeat as above using the top narrowing angle (usually 30° or 15°). Again, cut until some amount of surface has been cut all the way around. This operation lowers the top edge of the seat.

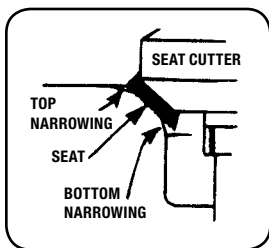

Final Seat Cut

- Before making the final cut, make sure that the width of the seat (i.e. the uncut surface between the top and bottom narrowing angles), is slightly less than desired finished width. Also, this uncut surface should appear uniform in width before making the final cut. If the width of the uncut surface varies significantly from one side to the other, continue cutting both the top and bottom narrowing angles until the width is uniform.

DETAILED CUTTING INSTRUCTIONS (continued)

- Cut the seat to the proper width. Let the cutter make a few turns with no pressure.
- The finished valve seat will have a machine textured finish (not highly polished or shiny). This provides a soft surface for final mating with the valve face in the first seconds of engine operation. It is not necessary to lap the valve.

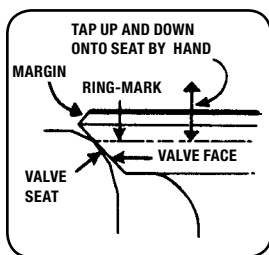
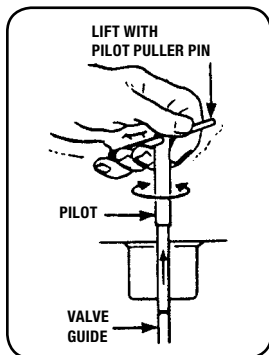

Inspecting the Seat

- Remove the pilot, using the pilot puller pin.
- Insert the valve into the valve guide.
- Using your fingers, tap the valve firmly against the valve seat, up and down in the valve guide, holding the valve above and below the cylinder head. Do this until a ring mark appears on the face of the valve.
- The valve seat should be located in the middle of the face of the valve, or just slightly off-center toward the margin. When the valve seat is properly located on the valve face (in the middle), the ring mark should appear about 1/4 to 1/3 of the way down the valve face from the margin. This ring mark is created by the ridge at the outer diameter of the 46° surface, where the 46° and 31° angles meet. When a 1° interference angle exists between the valve face and the valve seat, the 46° seat does not make full contact with valve. When the engine first fires these surfaces will mate together and full contact will occur. When cutting a non-interference seat—45° valve to 45° seat—the full width of the valve seat will contact the valve after cutting. In this case it may be useful to use Prussian blue, or a similar machinist's layout fluid, to visually check the location of the seat on the face of the valve.

Changing the Location and/or Width of the Seat

If the ring mark is too high on the valve face (i.e. too close to the margin), then cut more with the top narrowing angle. This will lower the ring mark on the face of the valve. However, it will also reduce the width of the seat. It may be necessary to cut the 46° surface again to restore desired seat width. Similarly if the ring mark is too low on the valve face, proper seat location can be restored by either cutting a bit more with the 46° cutter or, if seating surface becomes too wide, by cutting with both the bottom narrowing angle (usually 60°) and the 46° angle to obtain proper seat width and location.

Checking Valve Seat Concentricity and Closure

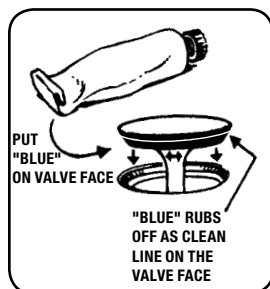
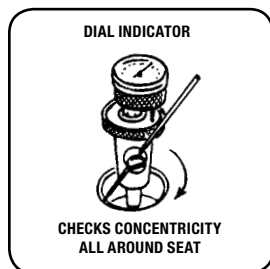

Valve closure relies on both the concentricity of the valve itself and the concentricity between the valve guide and the valve seating surface. Measuring the amount of concentricity, or runout, for each of these and adding them together provides us with the total amount of runout. It is this total runout which will determine how perfectly, or imperfectly, the valve seats. There will almost always be some amount of runout, it is therefore important to understand the allowable limit, or tolerance for runout. There is a simple rule of thumb: for every inch of valve head diameter the OEM will allow for 0.0015" of total runout. Higher revving engines will demand tighter tolerances.

Valve closure can be checked by painting the face of the valve with Prussian Blue. Be sure that the valve you use is true. Insert the valve into the guide and apply light pressure, turning the valve back and forth 1/8" or so. A contact pattern will appear on the valve face. One or more open spots may appear. Very short intermittent open spots (shorter than the distance from 12 to 1 on a clock) do not indicate a problem and will peen out immediately when the engine fires. Larger open spots (from 12 o'clock to 2 o'clock or 3 o'clock) can be remedied by returning the cutter to the seat and lightly turning the cutter a few revolutions with the fingers. If the open spot is larger than 90° (12 o'clock to 3 o'clock) repeat the three cutting steps, making very light cuts, or contact Neway Manufacturing for technical assistance at (800) 248-3889.

Special Application Carbide Blades

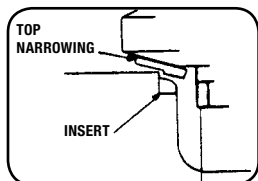
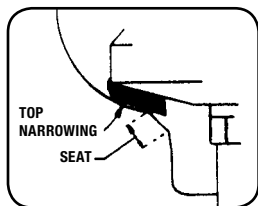

- Newway radius blades are used to smoothly blend the outer diameter of the top narrowing angle (usually 30° or 15°) into the combustion chamber wall. Steps or ridges may exist at the outer diameter of seats due to a recessed seat or a hemispherically shaped combustion chamber. The radius blade is installed in a top narrowing angle and positioned to cut out the step using the radiused end of the blade. One blade or multiple blades may be used.
- Special stepped blades may be used on recessed seats when it is necessary to clear the casting.

Power Unit

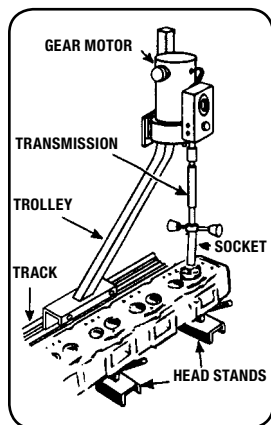

A Newway power unit will dramatically increase your productivity. The drive unit rolls freely along the track for positioning over the valve seat. The variable speed control allows for setting the most effective turning speed. Most seat materials are cut between turning speeds of 20 RPM to 50 RPM. For harder seat materials use slower speed. Excessive RPM (70 or more) may cause premature dulling of blades.

The transmission unit from the motor to the cutter has two universal joints and a telescoping section. The socket should be positioned directly over the valve seat being cut.

OPERATING INSTRUCTIONS

- Place cylinder head onto head stands.
- Insert pilot, as described previously.
- Adjust cylinder head such that the pilot is aligned to the transmission.
- Place cutter onto pilot and carefully lower cutter onto the valve seat. Do not drop the cutter as this may gouge the seat and/or chip the carbide blades.

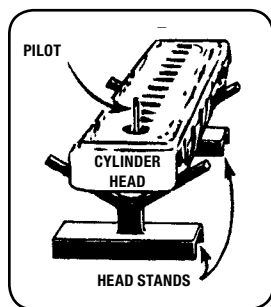

- Place socket onto the cutter. Be sure the transmission is lined up over the pilot. The transmission should be as straight as possible.
- Using the foot switch, start the motor to proceed with seat cutting as previously described. Holding the handle apply only light downward pressure. Excessive pressure may flex the pilot and/or cause premature dulling of blades.
- For more aggressive stock removal alternate blades may be used. Contact Neway.

Basic Parts List

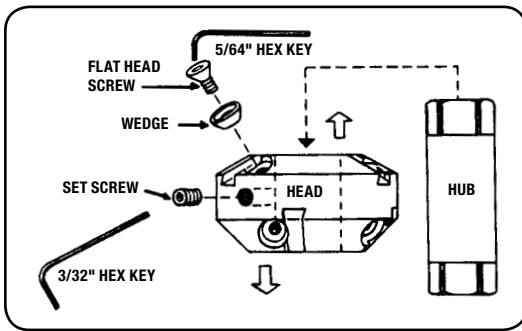

- HUB:** 1. Adjustable only on two-sided Narrowing Cutters—200 and 600 Series.
2. Fixed (not movable) on all other Cutters.

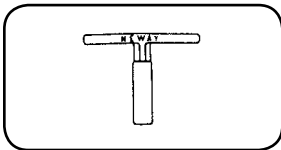

513—3/8" (9.5mm) Hex
for 100 Series Heads

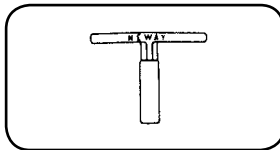

505—1/2" (12.7mm) Hex
for 200, 600, 700 Series Heads



503-1—3/8" Adaptor
1/2" to 3/8"

SOLID PILOTS

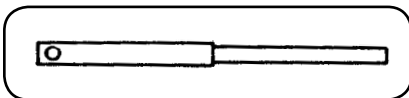

100 Series—For use with 100 Series Cutters only—.297" (7,5mm) Hub I.D.

140 Series—For use with 200/600/700 Series Cutters only—3/8" (9,5mm) Hub I.D.

EXPANDABLE PILOTS

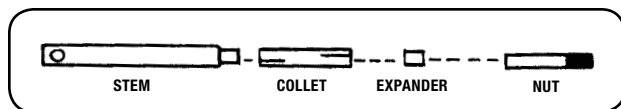

Collet diameters are ,1mm (.003") less than stated, and expand up to ,5mm (.020")

120 Series—For use with 100 Series Heads only—.297" (7,5mm) Hub I.D.

150 Series—For use with 200/600/700 Series Heads—3/8" (9,5mm) Hub I.D.

200 Series—For use with 200/600/700 Series Heads—3/8" (9,5mm) Hub I.D.
(They are for engines with long valve guides)

TUNGSTEN CARBIDE BLADES

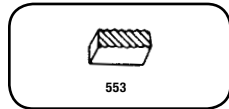
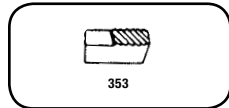
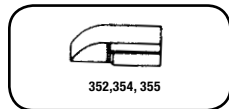
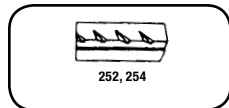
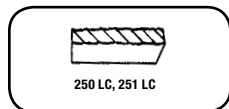
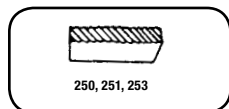
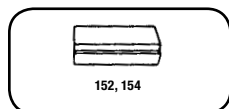

PART #	LENGTH	USED IN
--------	--------	---------

152	1/2"	Non-serrated Blade (correction cutters)
154	3/4"	Non-serrated Blade (correction cutters)
250	3/8"	0° thru 46° Seat Cutters
250 LC*	3/8"	0° thru 46° Seat Cutters (hard seats)
251	1/2"	0° thru 46° Seat Cutters
251 LC*	1/2"	0° thru 46° Seat Cutters (hard seats)
252	1/2"	60° thru 80° Correction Cutters
253	5/16"	0° thru 46° Seat Cutters
254	3/4"	60° thru 80° Correction Cutters
352	1/2"	Radius Blade (blending purpose)
354	3/4"	Radius Blade (blending purpose)
355	3/8"	Radius Blade (blending purpose)
353	5/16"	Honda Power Products (stepped)
553	5/16"	Suzuki Motorcycles (short-angled)

* LC (large course tooth) blades tend to be more effective on the hardest seat materials. They may also be used for more aggressive stock removal on regular or soft seat materials (e.g. to enlarge seat for oversized valve).

Helpful Suggestions

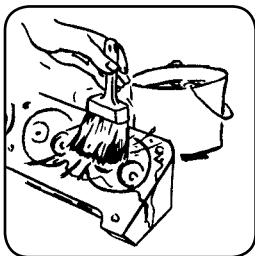

Clean up cylinder head after cutting seats.

Wash or rinse thoroughly with a cleaning solution.

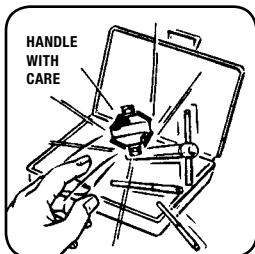

Take proper care of cutters and pilots.

Tools should be kept in tool case. When removed from case, they should be placed on a cloth or pad. These precision instruments will last a long time if reasonable care is used.

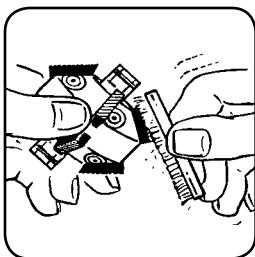

Take proper care of cutting blades.

Serrations on the blades should be cleaned regularly with the brush provided with each kit. A toothbrush may also be used.

Cutting soft seats.

Neway Cutting Fluid (a wetting solution) is recommended when cutting soft seats. This will reduce chatter and improve seat finish. Never use petroleum-based cutting fluid.

Cutting hard seats.

Neway's L.C. (large course) blades are recommended for cutting especially hard seats. In general, they should not be used on average to soft seat materials. However, they may be used on average to soft seats where aggressive stock removal is the objective. Increasing cutting pressure (feed) and decreasing cutting speed will also improve results on hard seats.

Repositioning worn or nicked blades.

The cutting blades do NOT have to be in the same relative position of the head. Blades may be up, down, or centered in their slots. They will always be on the same plane and angle. However, blades must extend over the seat area to be cut, with pointed ends toward hub. All blades on the same cutting angle should be replaced together. Since each blade is adjustable, worn portions or a nick can be adjusted away from the blade contact area. DO NOT OVER-TIGHTEN.

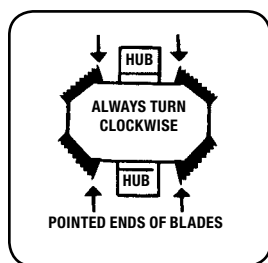

Assemble blades correctly.

Always be sure pointed ends on carbide blades are pointing toward the hub, or center of the head.

Troubleshooting

Occasionally problems are encountered. Here are simple solutions.

Situations	Probable Cause	Solution
Gouging	Too much pressure. Turning speed too fast.	Apply only light pressure. Slow down. Use two hands on T-Wrench.
Chatter	Incorrect pressure.	Apply only light pressure.
	Loose pilot.	Select snug-fitting pilot or replace valve guide.
	Very soft seats.	Apply wetting solution such as Neway Cutting Fluid on seats. Do NOT use petroleum-based cutting fluids.
Eccentricity	Too much pressure.	Apply only light pressure.
	Side load pressure.	Apply pressure over centerline of pilot.
	Loose pilot.	Select snug-fitting pilot, or replace valve guide.
	Excessive valve guide wear.	Replace valve guide.
"Load-up" in blade serrations	Too much pressure.	Apply only light pressure.
	Dirt or oil.	Clean serrations.
Excessive blade wear	Too much pressure.	Apply only light pressure.
	Wrong blade position.	Pointed ends of blades must be pointed toward hub.
Blade chipping or breakage	Rough handling or cutter dropped onto seat.	Tungsten carbide blades are very hard, but brittle, and should be handled with care.



neway



Neway has been in business since 1952 manufacturing and distributing tools and equipment for valve seat reconditioning and valve reconditioning.

Our "trademark" product is the Neway valve seat cutter. Neway seat cutters are almost standard equipment in shops that rebuild engines, whether the work is automotive, motorcycle, power equipment, or heavy duty. Our tools are used all over the world in shops both big and small, by DIYers and production engine builders alike. Neway cutters can be found at the track, in high performance test labs, and in use on OEM assembly lines. We believe that our product has been so successful for one simple reason: it offers value. It's extremely easy to use, is accurate enough for high performance engine work, and is inexpensive to purchase.

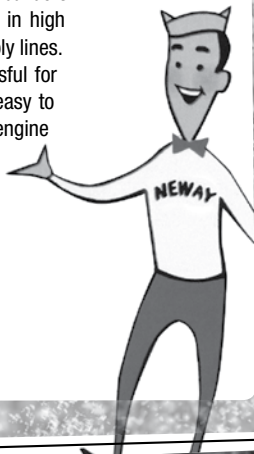

1-800-248-3889